

INTRODUCTION

The range of **ISOpac 10** Chiller Acoustic Packages have been continually developed over many years to reduce the radiated Sound Levels from Air Cooled Chillers, whilst combining a visually pleasing appearance.

The **ISOpac 10** gives a reasonable level of acoustic performance - typically a 10dB(A) reduction can be achieved which, combined with excellent airflow characteristics with low pressure loss, means that this Package is the ideal addition to the Chiller.

All Acoustic Packages are designed to suit your individual project, our Team of Sales Engineers can assist with the design of the Chiller Package for the optimum selection.

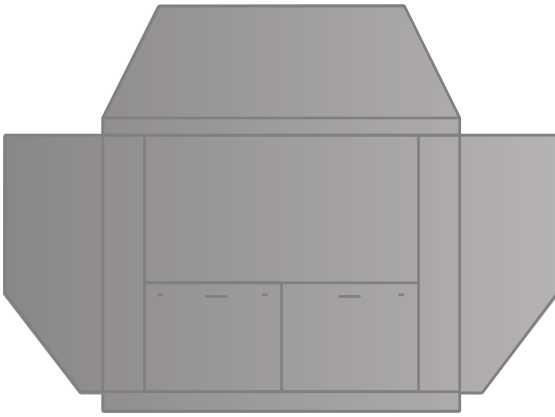

DESIGN AND MANUFACTURE

The **ISOpac 10** Chiller Acoustic Packages are designed to be free standing either on a builderswork plinth, or on a Conabeare Acoustics Limited purpose made acoustic floor, with additional support steels, to reduce noise breakout from the underside.

Due to the flexible nature of the design, the Chiller Acoustic Package can be used to attenuate a wide variety of Chiller sizes, from 2 fans up to multiple Chiller units with 48 or more fans.

The Chiller Acoustic Package has minimal visible fixings, with the only external hardware being for the hinged/removable access panels to facilitate maintenance.

All Packages are supplied in kit form for site assembly and hence are demountable for fan or compressor removal.

These Packages are supplied, as standard, in Goosewing Grey pre-coated steel sheet. However, it is possible to Polyester Powder Coat the external faces to any Standard RAL Colour.

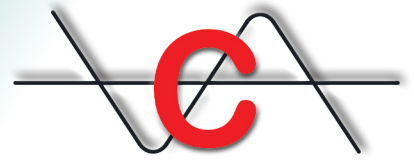

PERFORMANCE DATA

The **ISOpac 10** Chiller Acoustic Package has the following typical Acoustic Performance when measured horizontally from the side of the unit at a height of 1.5m from the base of the Chiller based on Free Field propagation.

Insertion (dB) at Octave Band Centre Frequencies (Hz)

63Hz	125Hz	250Hz	500Hz	1000Hz	2000Hz	4000Hz	8000Hz
5	6	8	9	11	13	15	14

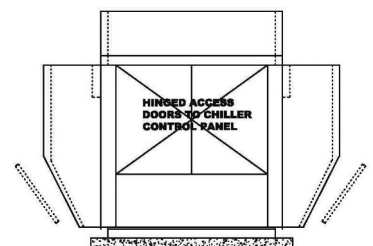
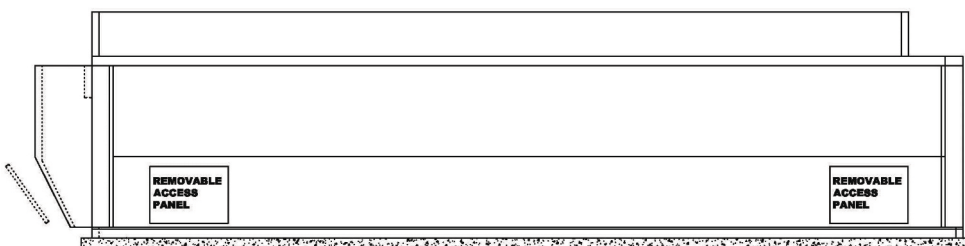
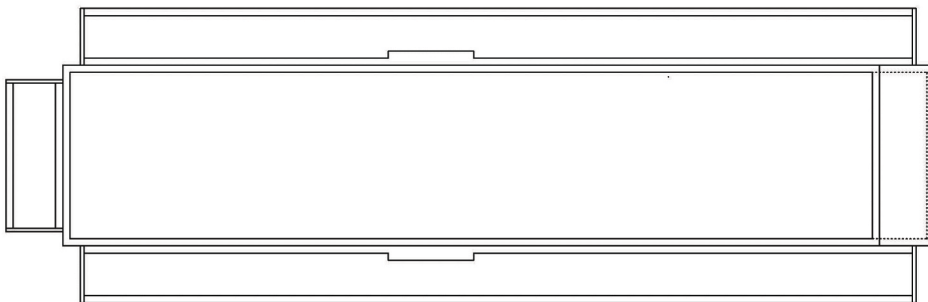
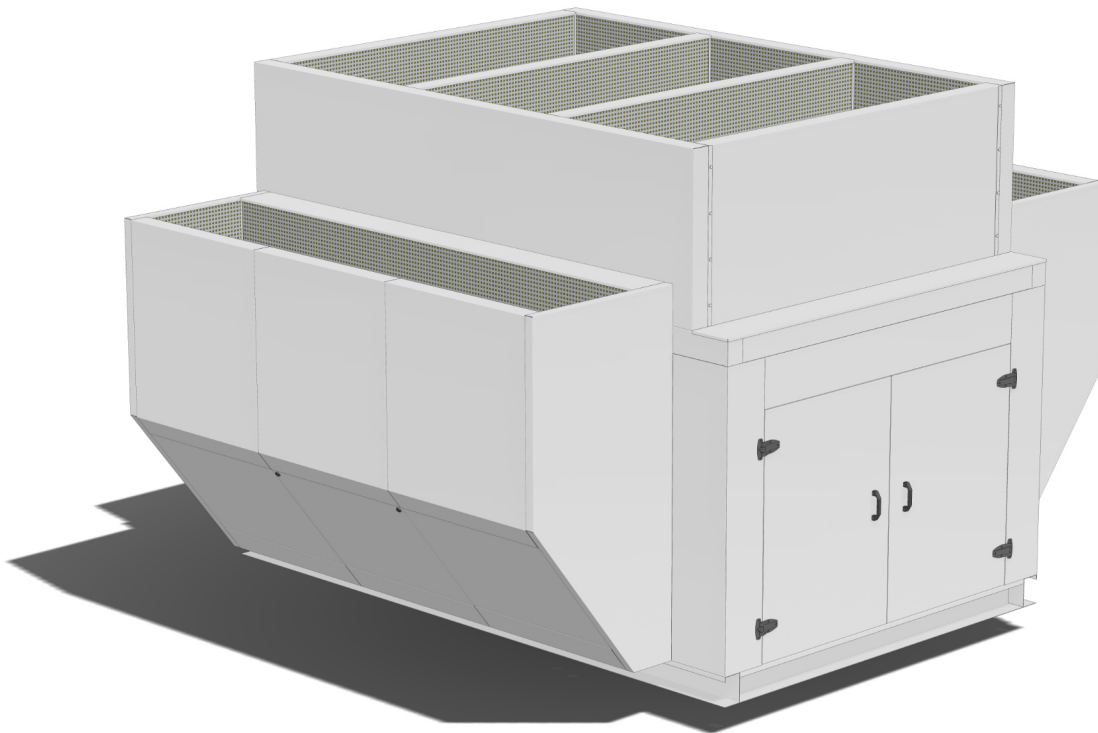

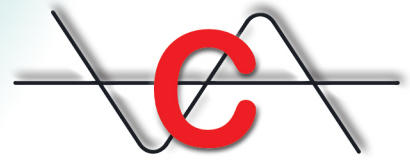

TYPICAL SPECIFICATION

ISOpac 10 Chiller Acoustic Package

Manufacturer:	Conabeare Acoustics Limited - 0118 930 3650
Product Type:	ISOpac 10 - Chiller Acoustic Package.
Materials:	Colour Coated Steel Sheet - 1.0mm thick throughout.
Frame:	3.0mm pressed pre-galvanised steel frame.
Acoustic Infill:	45kg/m ³ density mineral wool retained behind glass fibre tissue facing and expanded metal skin having minimum 30% free area.
Finish:	Goosewing Grey Colour Coated Steel Finish as Standard.
Description:	Fabricated Steel Chiller Attenuation Package comprising pre-galvanised or colour
colour	coated steel components throughout.

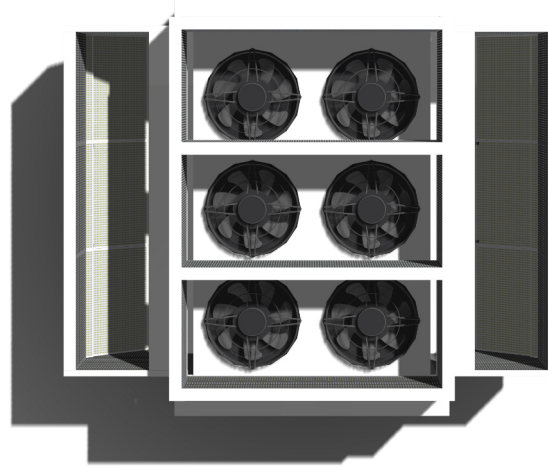

AVAILABLE OPTIONS

- Polyester Powder Coat to a Non-standard RAL Colour.
- Polyester Powder Coat to a RAL Metallic Colour.
- Colour Coated - Pre-finished steel fabrication. (Subject to availability)
- Steelwork Supports.
- Acoustic Floors with additional package support steelwork.
- Supplied in conjunction with other Conabeare Acoustics Limited products.

AVAILABLE SIZES

The **ISOpac 10** Chiller Acoustic Package can be supplied to suit Chillers from 2 fans up to multi modules or multi Chillers for 48 or more fans.

ENVIRONMENTAL CONSIDERATIONS

All items are produced in the UK from UK sourced suppliers, and are constructed from recyclable materials throughout.

All items are supplied to ensure minimal handling, transportation and waste. All raw materials are ordered on a project by project basis to facilitate this.

The package is supplied flat-packed in stackable modules so that all transportation is minimised.

All packaging is kept to a minimum and mainly consists of wooden pallets, recyclable cardboard and bubble wrap.

Conabeare Acoustics

Quality Noise Control Solutions

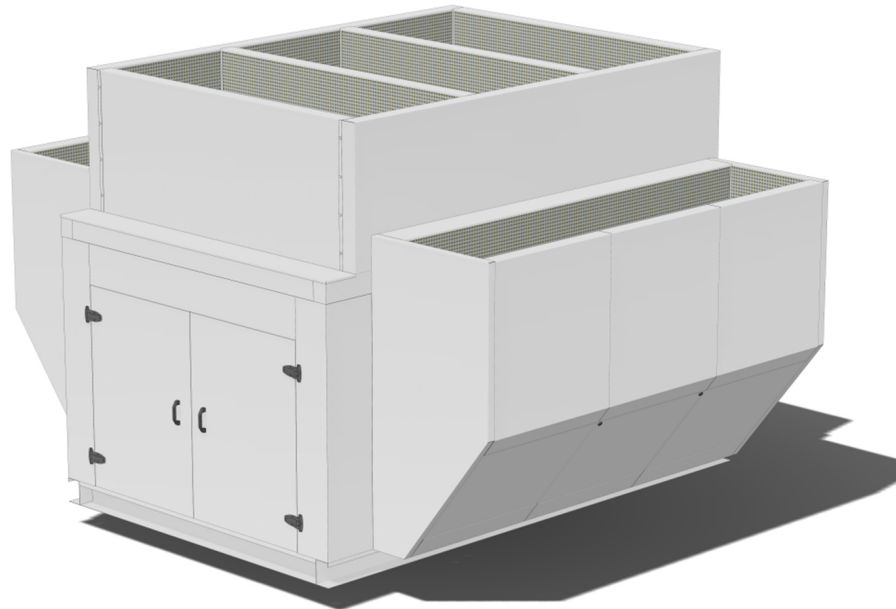
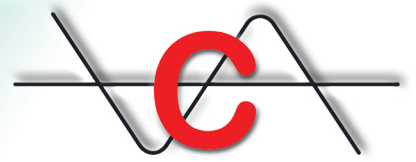

Acoustic Chiller Package - ISOpac 10

11 Chiltern Enterprise Centre, Station Road, Theale, Berkshire. RG7 4AA.

Telephone [0118 930 3650](tel:01189303650)
sales@conabeare.co.uk

Facsimile [0118 930 3912](tel:01189303912)
www.conabeare.co.uk



ISO10 - 25.01